

**Stormsaver Rainwater Harvesting System
Installation and Operation Manual**

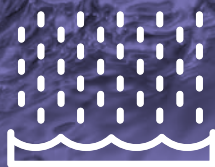



Contents

Section 1

Introduction

Section 2

Groundwork and installation of tank

Section 3

Intallation of mechanical works

Section 4

Intallation of electrical works

Section 5

Pipework and labelling

Section 6

Optional Extras

Section 7

Running the system and troubleshooting



Introduction

Thank you for your purchase of the Stormsaver system from FloPlast, designed for rainwater harvesting in family homes.

This installation manual contains important information, which must be observed during installation. It is imperative that this manual is read and understood by those involved with the professional installation of the system. This manual should be kept on site during installation of the system for easy access and reference. For additional copies please download from our website: www.floplast.co.uk or contact 01795 431731.

Please read these instructions carefully before installing the system.

The Stormsaver rainwater recovery system requires specialist installation. If you do not have relevant experience, please contact a contractor who does, or call FloPlast for further advice on 01795 431731.

WARNING

Failure to correctly install the system will invalidate the warranty! It is the responsibility of the installer to comply with the Water Supply (Water Fittings) Regulations 1999.

Standards, Guidelines & Certifications

The Stormsaver System complies with the standard for rainwater harvesting systems, BS8515-2009 and complies with the Water Supply (Water Fittings) Regulations 1999 which confirms the "independent inflow" required for reliable separation of service water and the potable water connection which is integrated in the system. The voltage is supplied through a switching power supply. All external components of the system operate using safe low voltage technology. The model brought to market incorporates design, construction and materials which satisfy the basic safety and health requirements of the EC Directive for Machinery. This declaration becomes invalid if any modifications are made to the equipment without our approval. In particular this equipment meets the requirements of the EU directives:

EC Directive for Machinery (89/392/EWG) version 91/368/EWG EC Low Voltage Directive (73/23/EWG) EC Directive for Electromagnetic Compatibility (89/336/EWG) version 93/31/EWG

The CE mark confirms the compliance of the equipment with the above directives.



Introduction

Compliance with current legislation

Those installing the Stormsaver system should be conversant and compliant with all current legislation and all relevant documentation pertinent to the rainwater harvesting installation. The following list can be used for guidance and is not a definitive list to those installing the Stormsaver rainwater harvesting system.

- Health and Safety at work Act
- Construction (Design Management) Regulations
- The Building Regulations
- Water Supply (Water Fittings) Regulations 1999
- The IEE Wiring Regulations for Electrical installations 17th Edition
- Regulations under the Electricity Act
- Control of Substances Hazardous to Health Regulations
- British Standards - BS8515
- The Chartered Institution of Building Services Engineers Guides, codes of practice and commissioning codes.
- Water Regulations Advisory Scheme Information and guidance Note No 9-02-05 marking and identification of pipe-work

Installation standards

All works to be carried out in accordance with the requirements of the Institute of Electrical Engineers, The Chartered Institute of Building Service Engineers, The British Standards Institute, Building Regulations and current good working practices. If there are any queries regarding the rainwater system please contact FloPlast Tel: 01795 431731.

Safety instructions

The installation instructions and user manual must be read carefully before installing the equipment. The instructions given here must be adhered to precisely otherwise all warranty claims will become invalid. The operator of the equipment is responsible for adhering to the safety and installation conditions. Only the original packaging, which is designed for transporting, is to be used when moving the equipment. The emergency overflow must always be connected.

As a safety precaution (in case of improper operation, dry running etc.) the equipment will automatically shut off after running continuously for more than 2 hours (the display will flash). After such an event the equipment can be switched on again by disconnecting and reconnecting the plug in the electrical socket or by switching the isolator on and off at the fused spur. The equipment is not designed for continuous operation! Installations on a mains water pipe network may only be carried out by certified technicians.



Introduction

Delivery

The Stormsaver system components may be delivered to site by various sources - carrier services or haulage distributors. Large equipment will be delivered by haulage distributors (such as the storage tank).

FloPlast will endeavor, where possible, to deliver components to site at suitable times – HOWEVER THIS MAY NOT ALWAYS BE POSSIBLE. Should equipment arrive either early or late FloPlast cannot be responsible for delivery times.

Due to the nature of the product, the storage tank and system components may not necessarily arrive together. The customer or appointed contractor is responsible for unloading and securing the tank and equipment on site. The storage tank will be offloaded to the nearest hardstanding by the site contractor. A fee may be chargeable if goods are not accepted by site, if there is a delay in offloading or for goods returned without prior acceptance in writing from FloPlast.

Damage in transit

Stormsaver products are carefully checked and tested before dispatch, however the risk of damage during transit cannot be guaranteed.

- Check the goods for complete content and damage on receipt.
- Any damage is the responsibility of the carrier. Register any claim with them immediately
- A report must be made within three working days from date of delivery of any missing or damaged items. FloPlast cannot accept responsibility for missing or damaged items if not reported IN WRITING immediately.

Please contact your FloPlast Representative before returning any goods.



Groundwork and Installation of Tank

The underground tank stores the rainwater collected from the roof until it is required for use. The rainwater flows to the tank through sealed downpipes. On entry to the tank rainwater passes through an integral leaf filter which removes leaves and debris direct to an overflow. The water enters the main storage tank area through an inlet calmer to avoid stirring up any sediment which may have settled on the tank base. A floating suction filter sits just below the water surface suspended on a float so, when called for, the water drawn out the tank is not from the surface where pollen or dust may have settled. The floating suction filter ensures another level of filtering before the water enters the pipework to the following uses:

Equipment included with tank

- Shallow dig tank with integral filter and inlet calmer
- 235mm turret and pedestrian duty manhole cover
- Low level float switch fitted to bracket
- 20m of ½" suction hose
- Boosted floating suction filter kit



Vehicle washing



Landscape watering and sprinkler



Toilet



Garden watering



Domestic laundry

Rainwater should not be used for drinking or connected to applications where the water could accidentally be ingested.



Groundwork and Installation of Tank

Where to locate the tank

The tank must be located in a place where the distance from the edge of the excavation to the edge of the foundation, is at least double the difference in depth, from the base of the foundations to the base of the excavations. The red dotted line represents the line the tank excavation must not cross.

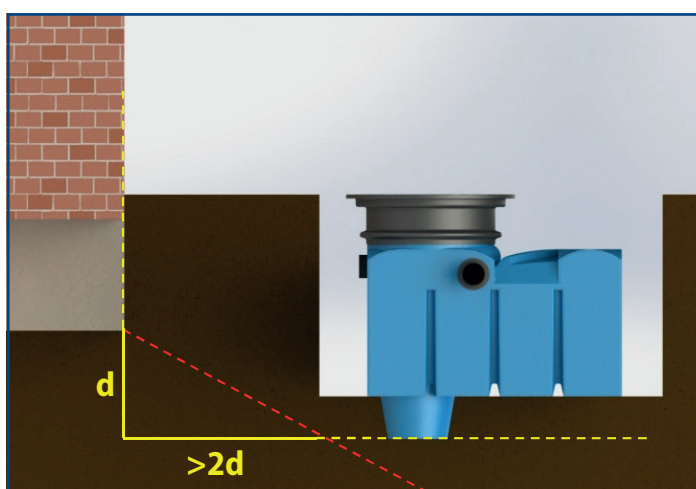

This graph demonstrates the maximum suction hose run length versus the maximum tank base depth as measured from the base of the control panel processor unit. The longer the run of the suction hose, the shallower the base of the tank must be, and the same is true in reverse.

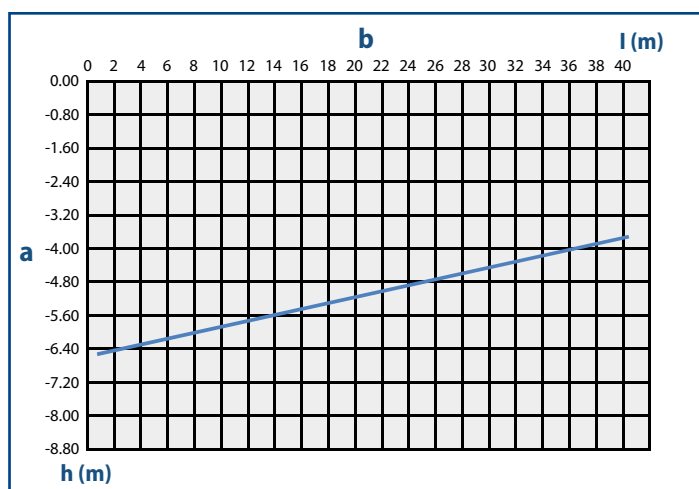

A – represents the DEPTH from the base of the processor unit to the base of the tank
 B – represents the LENGTH of the suction hose run from the control unit to the boosted suction filter, 150mm from the base of the tank.

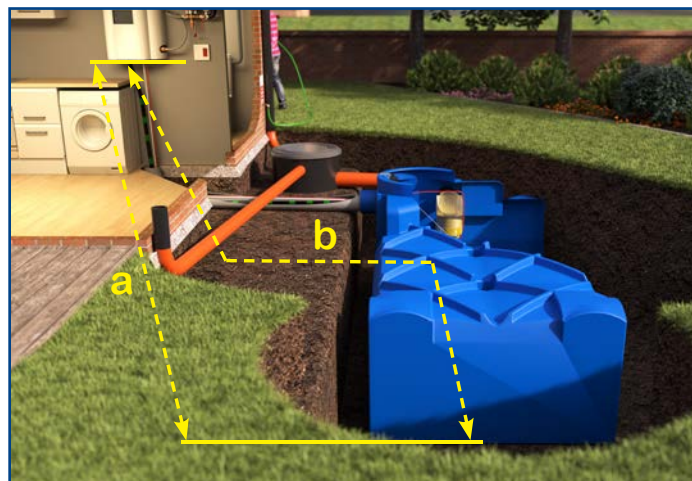

The installation must fall within parameters above the line on the graph. Installation which falls within parameters below the line may result in pressure problems and will not be covered by warranty.

Existing pipelines, pipes, vegetation as well as other specifics must be considered, so that damage or hazards will be avoided.

Installing the tank

Excavate a hole suitable for the size of your tank (see next step for sizing your excavation). Ensure the hole is in a suitable location as outlined above. Include a channel for the laying and connection of your pipework and 110mm service duct. Shore up the sides of your excavation.



Check tank size and excavate hole



Groundwork and Installation of Tank

Sizing your excavation

The excavation should allow for a minimum of 200mm surround to all sides and 500mm depth in addition to the tank dimensions. Lay 100mm sand on the excavation base, compact and level. Ensure there are no stones or edges which could damage the tank. If the tank has a sump, ensure extra space is excavated to accommodate this. Note. If you have purchased the extended turret the overall depth of the hole will be at most 900mm more than the tanks height but the turret can be trimmed to fit.

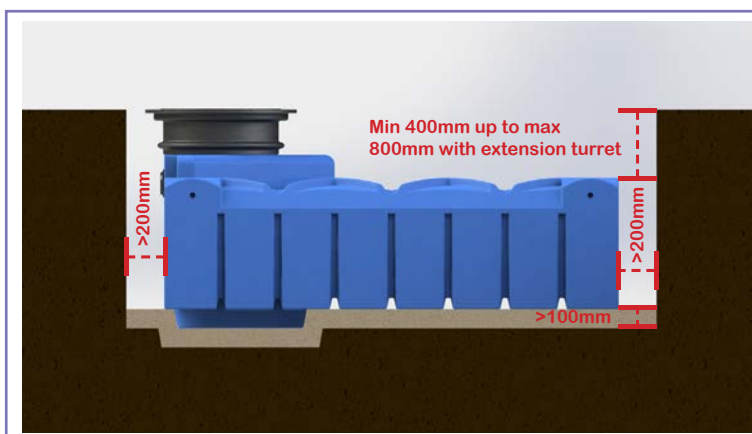
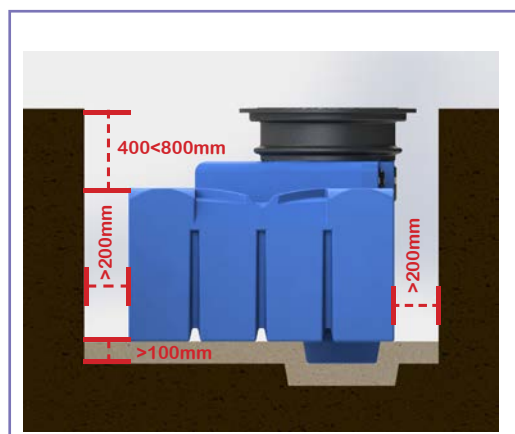
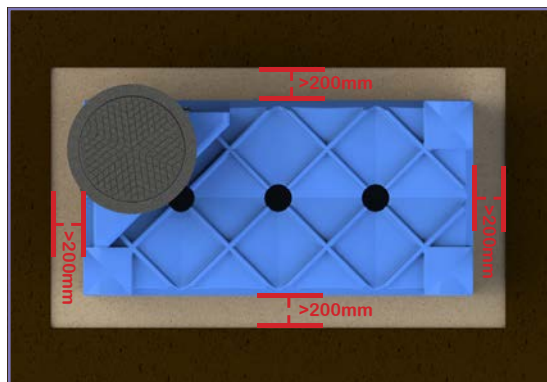

Carefully lower the tank into the excavation. Install and connect up all pipework, including the service duct for the floating suction hose and cabling.

1. Water collection point
2. Inlet to tank
3. Overflow
4. Service duct

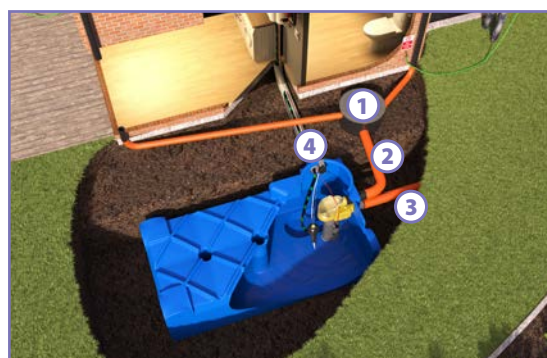

The tank must be installed level and the overflow pipe should have a deeper fall away from the tank than the fall from the feed pipe to the tank.

Ensure the 110mm service duct for the hose is laid with a $>1\%$ slope and that the hose within it is tauged to prevent air gathering in the suction hose. This can cause problems with the pumps running. The hose must be one continuous run, free from kinks, tangles or connections, between the tank and the control panel unit.





Groundwork and Installation of Tank

Fit the relevant manhole covers for the area – standard supply is pedestrian duty. Ensure these are fitted prior to backfill to avoid debris entering the tank. Any debris must be removed prior to the system being used as this can affect the systems function. Begin filling the hole with type 1 aggregate or sand, avoid filling materials with sharp edged particles.



Fit Turret

Top soil, clay, loam and other types of cohesive soils and materials with sharp edges are not suitable filling materials. Carefully backfill type 1 aggregate to all sides and up to at least 100mm above the top of the tank, compacting at every 100mm interval. It is also important to compact the material down into the column supports in the tank.

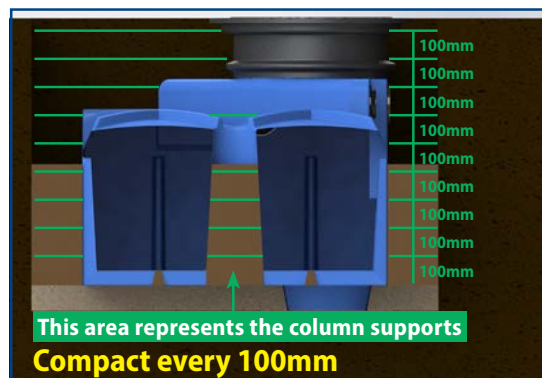

Ensure that the top of the tank is covered with at least 100mm of the filling material before filling the remaining (minimum) 400/800mm of the hole, bringing it up to ground level, with a material of choice suitable for the location of the tank.



Complete tank burial

Completing the tank installation

Ensure any gaps at the point of the ducting entering the building are sealed using expanding foam or wall bush to prevent odour or drafts entering the building.





Groundwork and Installation of Tank

Sealed gully

Run all downpipes into sealed gullies or pipework at ground level so that rainwater from the roof area only and not groundwater can enter the tank.

Stormsaver recommend that a universal rainwater adaptor (D96 available from www.floplast.co.uk) is used.

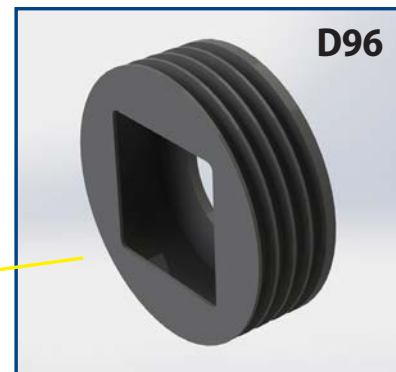
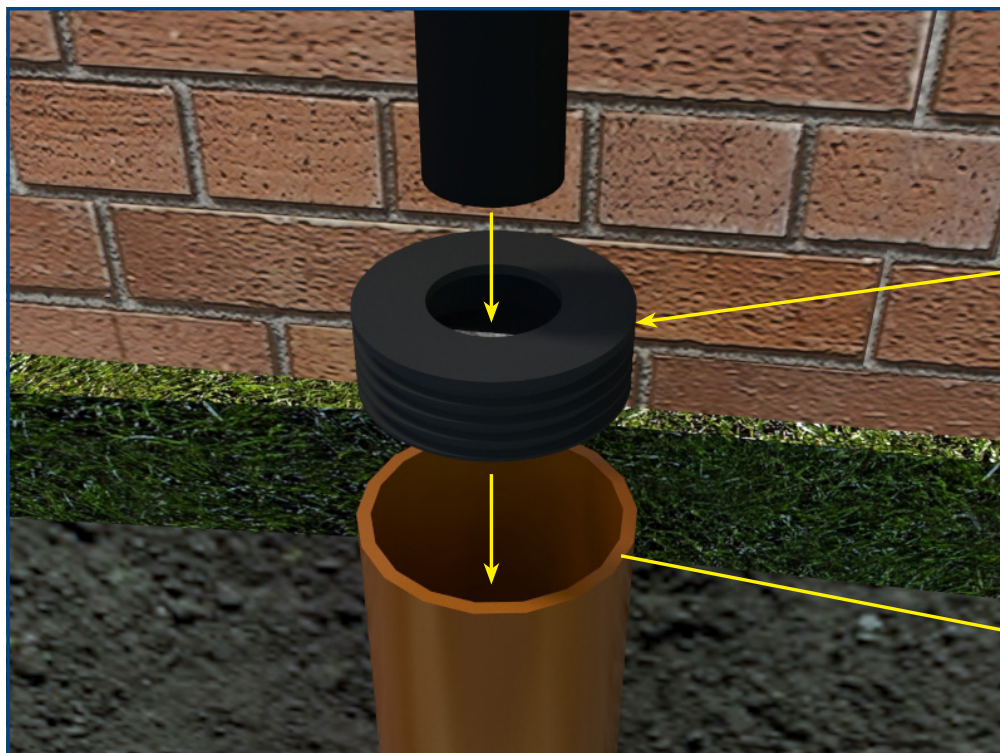

Open gully

Open or grated gullies (such as the one shown) are not to be used as they allow surface water and other unwanted

liquids, debris or contamination to enter the rainwater storage tank.



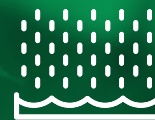

Installation of Mechanical Works

WARNING! Please read these instructions carefully before installing the control panel.

The Stormsaver rainwater harvesting system requires professional installation. A competent plumber should carry out all plumbing works. If you do not have relevant experience, please contact an installer who does, or call FloPlast for further advice.

All materials used within the installation must be non-corrosive and suitable for construction, operation, and maintenance including all chemicals, disinfection agents and all materials in contact with equipment. The installation should meet standards set by WRAS Water Supply (Water Fittings) Regulations 1999.

The regulations state that the rainwater should be supplied in black and green or black pipework or marked with labels, different to that supplying mains water supply. This is to ensure that pipework is clearly identifiable and avoid cross contamination of the two supplies. Blue pipework must not be used for the rainwater installation.

Appropriate insulation must be applied to all pipework with the Stormsaver rainwater recovery system to prevent freezing or warming (not supplied).

It is the responsibility of the installer to ensure that all pipes and water fittings are clearly identified using approved

Stormsaver labels, this is essential to prevent confusion over the source of supply at any later date (available as an option).

An operating pressure of 2.8 - 3.5 bar is ideal for most conditions and it is the normal operating pressure within the system.

WARNING: if the unit and pressure switch is not set up correctly and the pump does not stop the pressure can rise to 10 Bar. Please contact FloPlast if you require further advice

WARNING: 10 Bar is the maximum pump pressure!

IMPORTANT NOTE: The control unit is rated low for noise - the unit also has a 48db rating. Stormsaver recommend where possible to install the unit in an out building or garage on a solid wall not stud. If this is not possible we recommend putting the unit in an area located furthest away from the bedrooms.

IMPORTANT NOTE: The floating suction filter kit and sensors should not be installed until all works have been completed on site which could produce cement based or other contaminating debris getting into the tank.

The tank should be cleaned after its installation and before installing the floating suction filter. Failure to do so can result in blockage of the suction filter which can damage the pump, leaving the building with no rainwater supply.

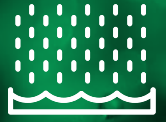

Installation of Mechanical Works

The Stormsaver control panel is the central hub of the system. All the rainwater must pass through here on its way to the points of use. The control panel is the place where all the different pipes and hoses connect up, and should be

considered when choosing its location within the building. The unit comprises of the pump, a small water storage tank, a pressure vessel and the electrical control panel which enables the whole system to function and includes the display panel.



Equipment included with panel

1. Control Unit
2. Mainswater connection set (flexible hose and shut off valve)
3. Pressure vessel kit (should be set at 1.6 bar)
4. Wall fixings for control unit
5. Pipe bracket (to support pressure vessel on wall)

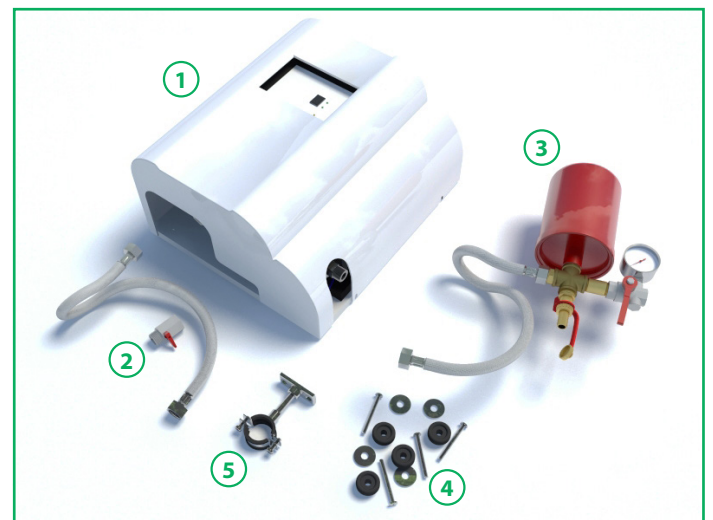

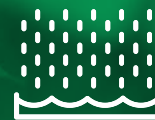

Installation of Mechanical Works

Mechanical works within tank

The control panel unit is supplied with a submersible pump kit, as it is critical that the system meets the requirements explained on the next page.

1. Non return valve with hose attachment
2. Waterproof electrical junction box
3. Jubilee clips
4. Hose attachment
5. Boosted submersible pump
6. Stainless steel lifting rope and L bracket
7. Float

Use a **continuous length** of suction hose through the service duct into the tank. Ensure it is pulled taught, lying flat in the duct and free of bends. Cut the suction hose to leave the required amount (see table) dangling into the tank.

| Tank Size: | 1500 Litres | 3000 Litres | 5000 Litres | 7000 Litres |
|----------------------|-------------|-------------|-------------|-------------|
| Pipe Length to leave | 1 Metre | 1 Metre | 1.5 Metre | 1.5 Metre |

Within the tank connect the float to the boosted submersible pump and then connect the boosted submersible pump to the suction hose as shown, using the supplied non return and hose attachment. Ensure the seals are tight!

Using the clip on the float, pull and extend it to fit in the grill holes of the booster pump. Please ensure a snug and secure fit.

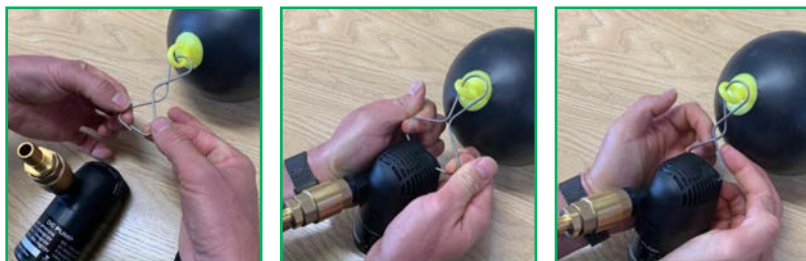

Screw the L-shaped steel bracket to the lip around the tank access hole. Make sure it is positioned above the service duct (as shown).

Stainless steel rope fixed to:

1. L bracket
2. Float

Attach the provided steel rope to the L shaped bracket and through the loop on the top of the float.

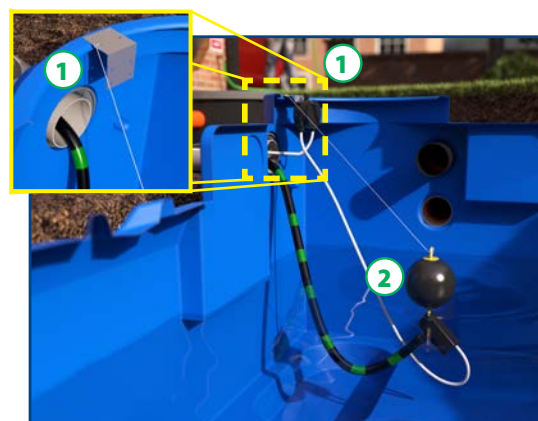
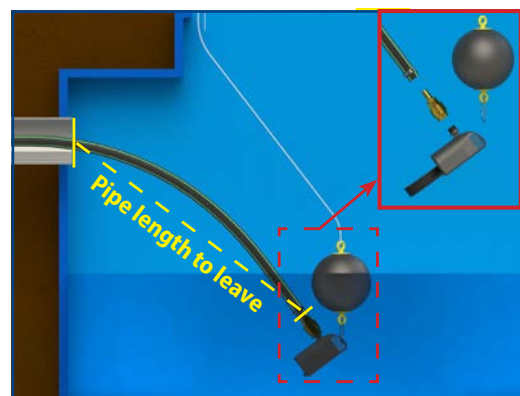
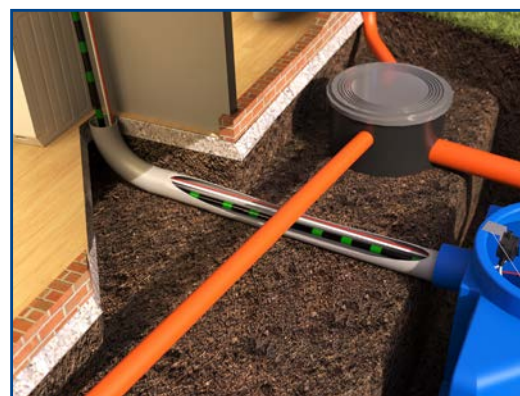



Installation of Mechanical Works

Where to locate the unit

The control panel unit is NOT weatherproof and must not be exposed to the elements. The unit should be located within the building. Extremes in temperatures should be avoided. Insulation will be required; the controls must not be subject to freezing conditions.



Do not mount the unit over a sink or water outlet as the control panel unit contains mains electric voltage.



This graph demonstrates the maximum suction hose run length versus the maximum tank base depth as measured from the base of the control panel processor unit. The longer the run of the suction hose, the shallower the base of the tank must be, and the same is true in reverse.

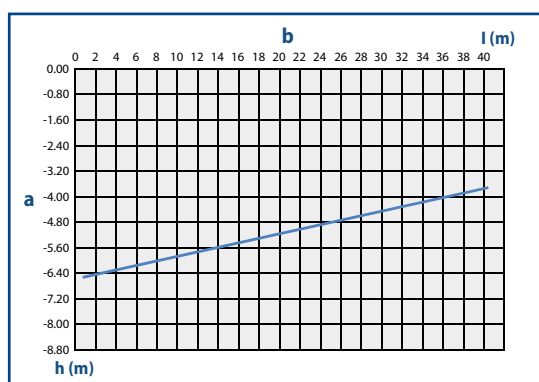

A – represents the DEPTH from the base of the processor unit to the base of the tank.

B – represents the LENGTH of the suction hose run from the control unit to the boosted suction filter, 150mm from the base of the tank.

The installation must fall within the parameters above the line on the graph. Installation which falls within the parameters below the line may result in pressure problems and will not be covered by warranty.

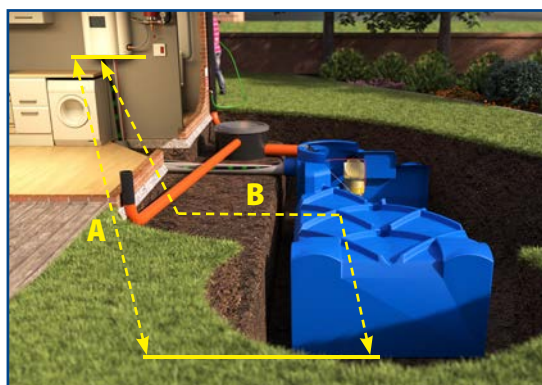

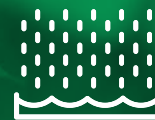

Installation of Mechanical Works

It is important to locate the unit where access can be gained for connection to:

1. Electrical supply (single phase 240V Fused Spur)
2. Supply of mainswater
3. Outlet rainwater supply to points of demand
4. Overflow to drain
5. Rainwater supply from storage tank
6. Electrical cabling from storage tank (housed in protective trunking)

Minimum distances to the ceiling and to the sides are to be adhered to for the purpose of installation and maintenance. The control panel is fastened with four screws M 6 x 40 (wall anchors \varnothing 8 mm), ensure all 4 screws are used in order to avoid vibrations. Make sure that the correct types of wall plug are used for the wall material.

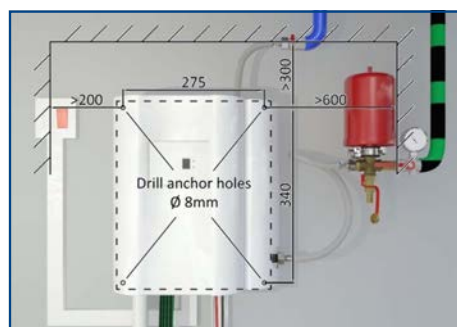
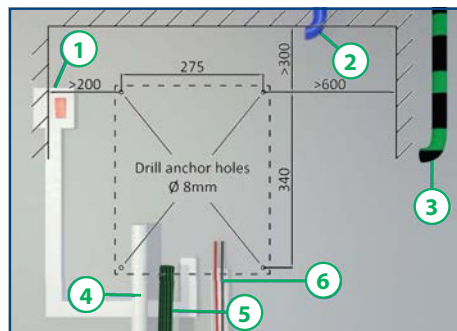

Connecting up the control panel

Connect all inlets and outlets up to the control unit. The connections are as follows:

- Mainswater supply (female $\frac{3}{4}$ "- $\frac{1}{2}$ " BSP)
- Outlet to Point of demand (female $\frac{3}{4}$ " BSP)
- Rainwater supply (supplied rainwater fittings)
- Drain (43mm waste pipe)

1. Connect $\frac{3}{4}$ " stainless still braided hose to the mains water inlet valve on the unit.(supplied)
2. Connect the isolator valve to the $\frac{1}{2}$ " stainless steel braided hose. (supplied)
3. Connect the isolator valve to the mains supply.

Its is strongly recommended to fit a Y strainer (not supplied) and second isolator (not supplied) prior to the braided hose and isolator to prevent debris within the mainswater pipe from blocking the inlet valve on the control panel unit.

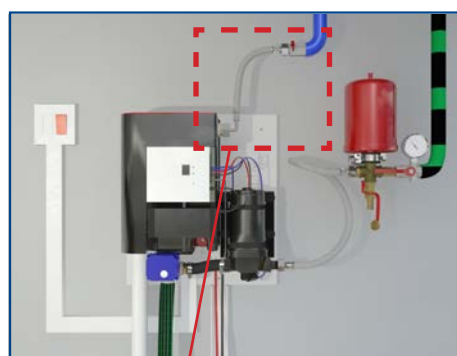



Installation of Mechanical Works

Assemble pressure valve as shown.

1. 1/2"-3/4" braided hose
2. Pressure vessel (set at 1.6 bar)
3. Cross piece
4. 1/2" draining tap
5. 3/4" pressure shut off valve
6. Pressure gauge

Use the included pipe clamp to hold the assembled kit to the wall.

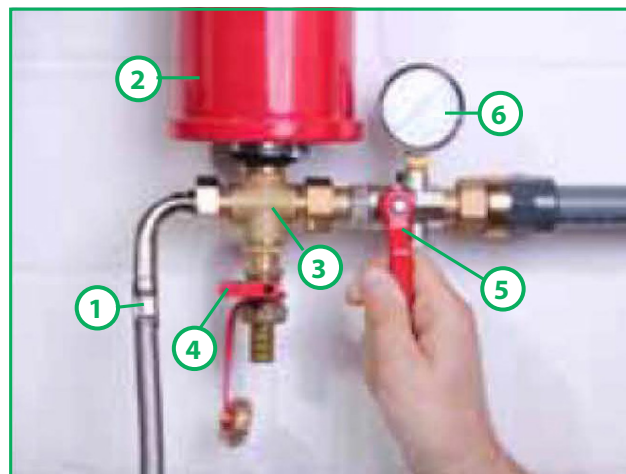

Connect the single length of the suction hose to the control panel unit as shown, using the fittings provided. It is essential that this is water tight as any leaks will allow air into the system, resulting in pump failure and from this other potential problems can occur.

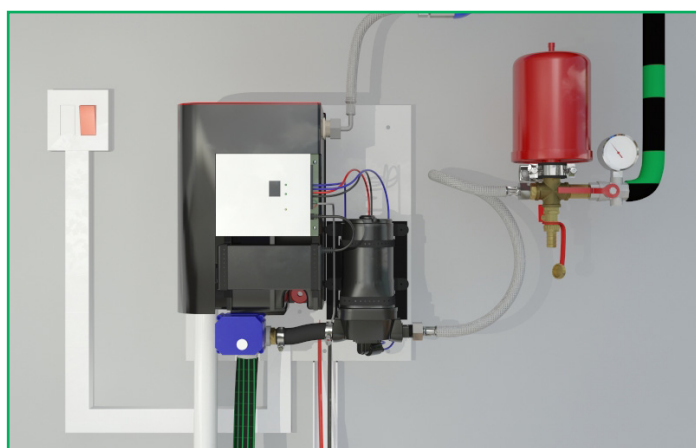

Using a WF08 36-45mm (not supplied) fitting connect a 43mm waste pipe (not supplied) to the overflow of the mainswater tank as shown. Run the waste pipe to a nearby drain, this will prevent water spilling onto the floor should the system overflow. The fitting and waste pipe are available from www.floplast.co.uk

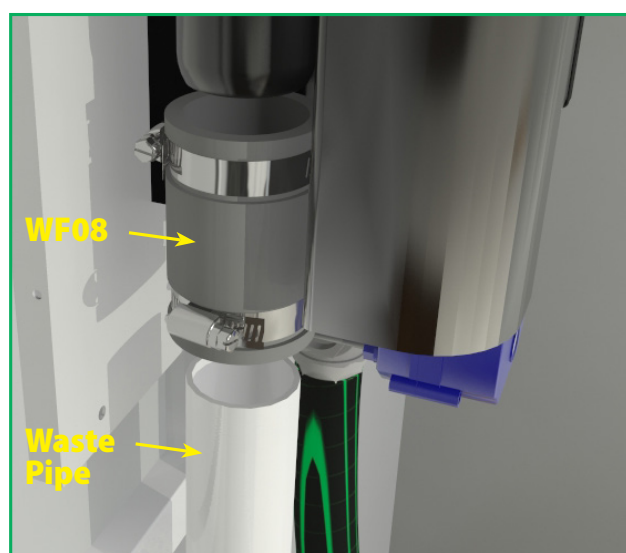
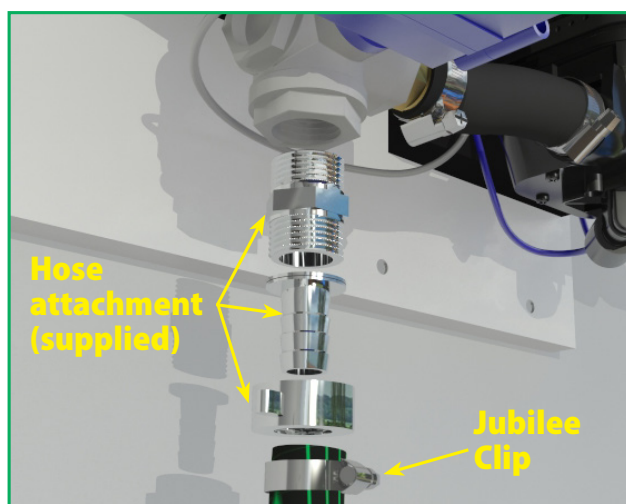



Installation of Mechanical Works

Completed System

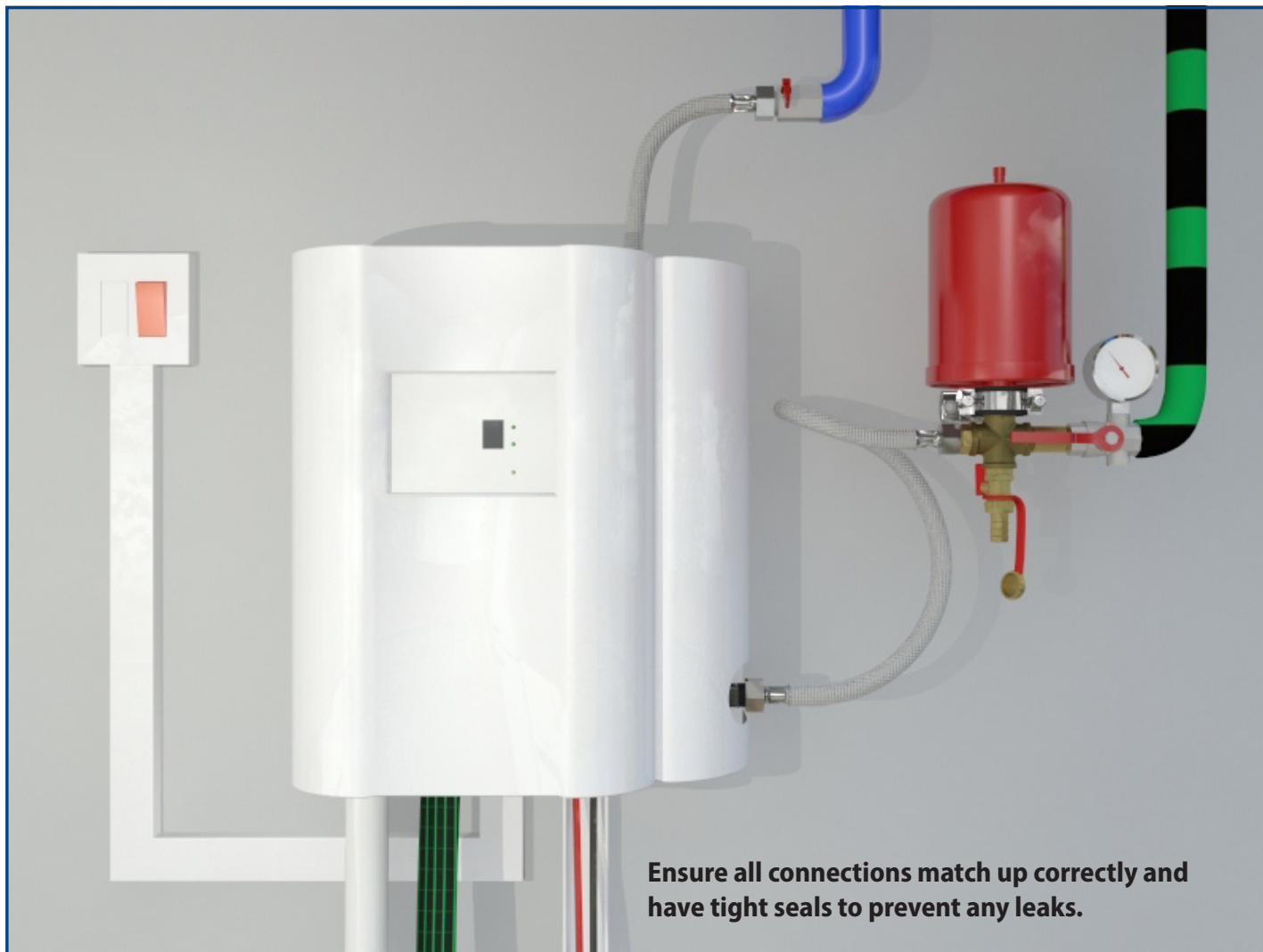

Ensure all connections match up correctly and have tight seals to prevent any leaks.



Installation of Electrical Works

WARNING! Please read these instructions carefully before carrying out electrical work.

The installer is responsible for providing all electrical wiring required in connection with the installation.

The electrical installation in connection with the Stormsaver rainwater recovery system shall comply with BS7671 Requirement for Electrical Installations, including the latest amendments and all current legislation.

The required items included with the Stormsaver system are, the power and control cabling, level switches and controls. The installer shall connect the control panel unit to electrical supplies as well as internal and external supplies, connecting appropriate supplies and provide all necessary fixings and fittings.

All power circuits should be provided with a 4A switch spur.

External wiring shall be a suitable type and shall be installed within the 110mm service ducts. This will carry power cables and other control cabling. These ducts will be buried in sand blinding.

All internal wiring to be installed in surface mounted galvanised steel conduit and/or trunking.

Note:

- The Control panel unit requires a 4A fused, isolated power supply. All connections inside the unit should be made into the correct terminal locations.
- External electrical connections should be rated IP68.
- A competently trained electrician must carry out all electrical works.



Installation of Electrical Works

Pull all electrical cables from the tank through the service duct to the the control panel unit. Avoid leaving slack in the cables. Follow the instructions on the next page for wiring into the panel.

Cable Spec

Use the relevant detailed cabling if you require more cable length than is supplied.

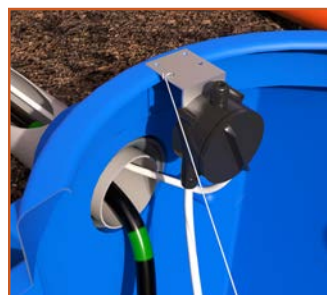
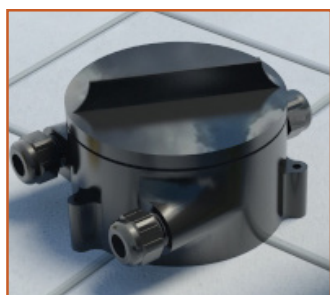
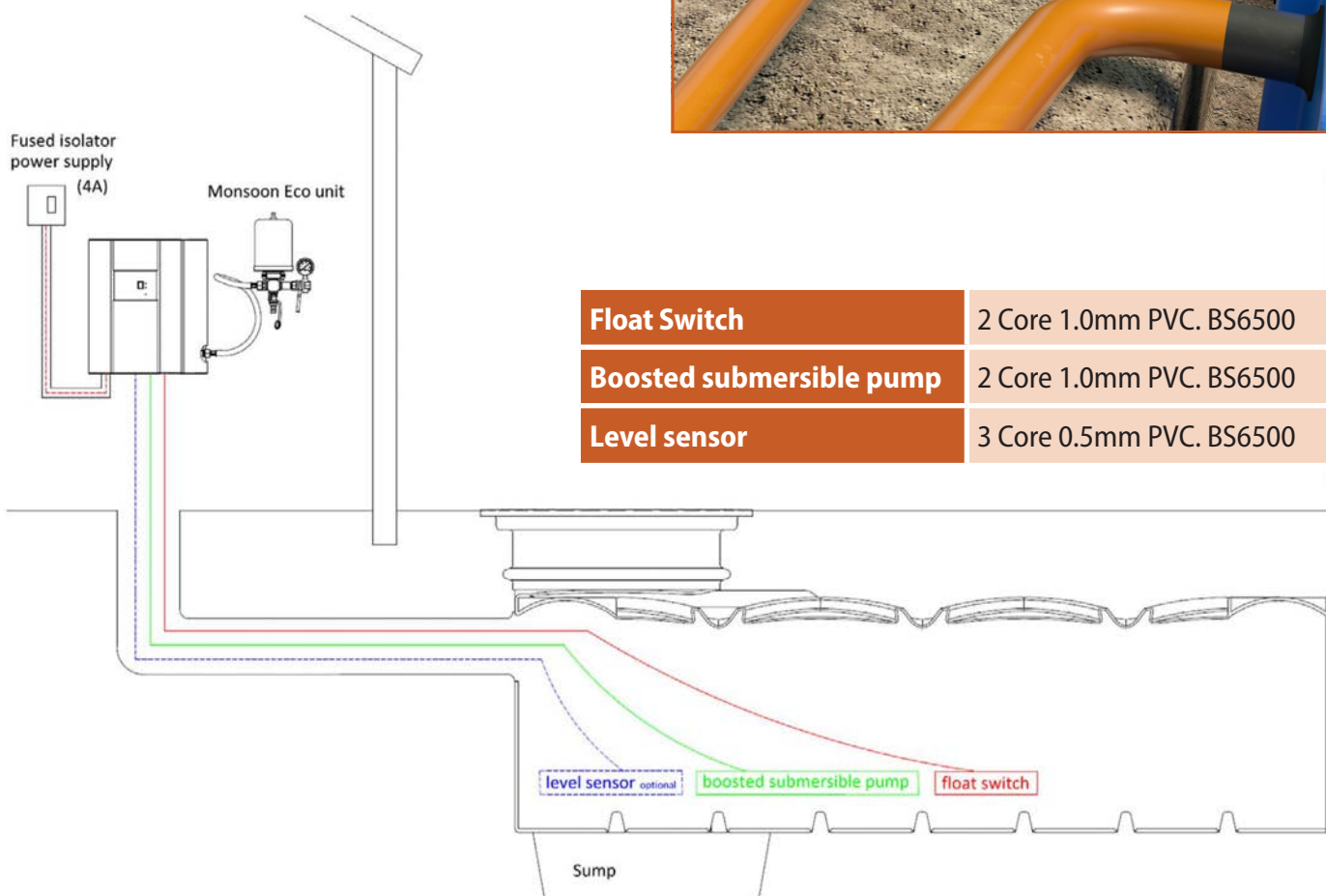

In cases where the cables are not long enough to reach the panel, run the cable into a waterproof junction box which needs to be mounted on the bracket in the turret

as shown. Within the junction box connect it to a length of the specified cable and run that through the duct to the panel.



Installation of Electrical Works

The installer should install cables between the control panel unit and the tank, with trunking used inside the building until the cables enter the service duct to the main storage tank. Where cables supplied are of insufficient length, it is critical that a single continuous

cable is fitted between the tank and the control panel unit. Connections within or near the tank must be terminated in a watertight junction box (as supplied). Connections should be connected within the control panel as shown above.

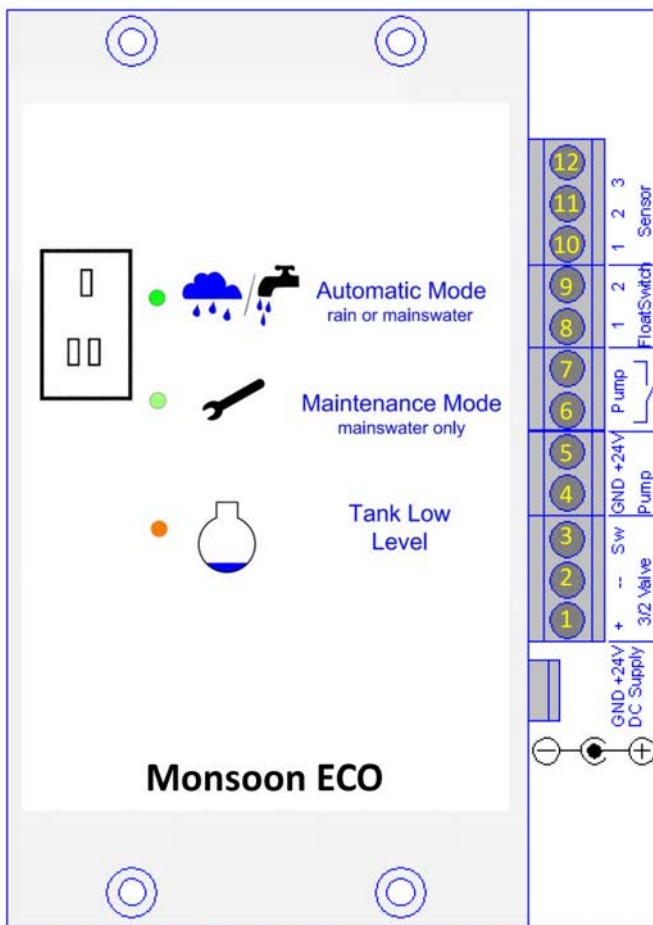

| Action required? | Description |
|------------------------------------------------------------------------------------------------|-------------------------------------------------------------------------------------------------------------------------------------------------------|
| Only if level sensor is fitted (will require terminating by an electrician) | Level sensor (see optional accessories section) - 3 = +15V (Brown) - 2 = Signal (Black) - 1 = GND (Grey) |
| Requires terminating by an electrician | Float switch - 2 (Blue) - 1 (Brown) |
| Pre-wired no action required | Pressure switch (no polarity) - (Red) - (Red) |
| Pump within unit is pre-wired. Boosted submersible pump requires terminating by an electrician | RM Eco pump + Submersible pump (Both pumps occupy the same terminals in the panel) - +24V (Red/Grey) - GND (Black/Blue) !! Check polarity !! |
| Pre-wired no action required | Motorised valve - Signal/GND (Green) - GND (Black) - +24V DC (Red) |
| Pre-wired no action required | 24V DC switching power supply - Ø 5.5 jack connector - Optional: connection to 24V battery supply |

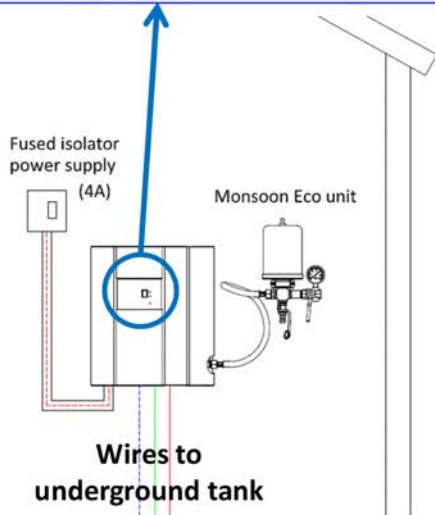

Boosted submersible pump:

Blue wire | **Terminal 4 (in parallel with Black wire)**
Grey wire | **Terminal 5 (in parallel with Red wire)**

Float switch:

Brown wire | **Terminal 8**
Blue wire | **Terminal 9**



Installation of Electrical Works

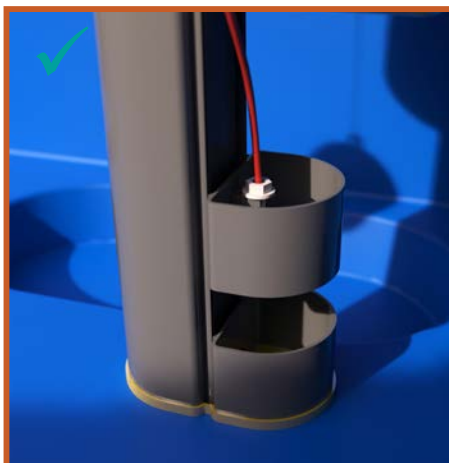
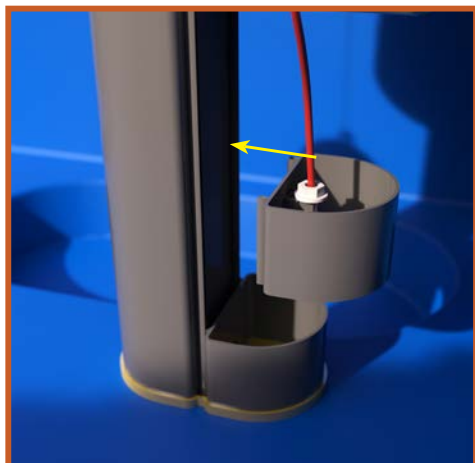

1. Screw in the low level to the D-clip.
2. Run the wire into the building through the service duct.
3. Attach the clip onto the rails of the filter downpipe, leave a minimum of 100mm from the inlet calmer to the low level clip in order to get maximum capacity.
4. Do not have the low level clip directly above the inlet calmer as this will cause the sensor to operate incorrectly.

Connect control panel unit to the mains electric using a 4A fused isolator.





Pipework & Labelling

To reduce the risk of cross-connection and contamination of the wholesome water supply it is essential that all reused water pipework is both readily distinguishable from other pipework and instantly recognisable wherever it is located, for example inside a property, beneath the street, or on private land.

So that accidental or deliberate operation, that could put the wholesome supply at risk, can be avoided, all

apparatus such as valves and washouts on systems distributing reused water should be suitably marked and significantly different from those normally used on wholesome water distribution networks.

Please use the following instructions in connection with the Stormsaver warning labels (available as an option) to ensure your system is correctly labelled and meets WRAS regulation standards IGN: No 9.02.05.

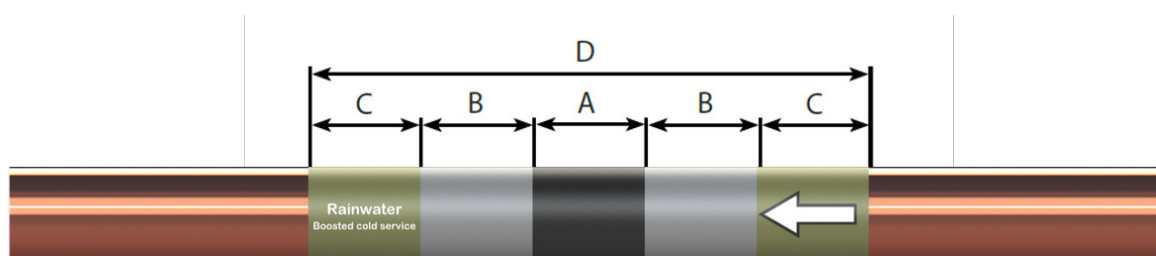

| Pipe diameter | A | B | C | D |
|----------------------------------|-------|-------|-------|-------|
| $d < 50\text{mm}$ | 30mm | 30mm | 30mm | 150mm |
| $50\text{mm} < d < 100\text{mm}$ | 75mm | 75mm | 75mm | 375mm |
| $100\text{mm} < d$ | 150mm | 150mm | 150mm | 750mm |

Examples of recommended labelling for pipework inside buildings. All pipework inside buildings should be labelled

as shown above to ensure it is easily identifiable as a rainwater supply.

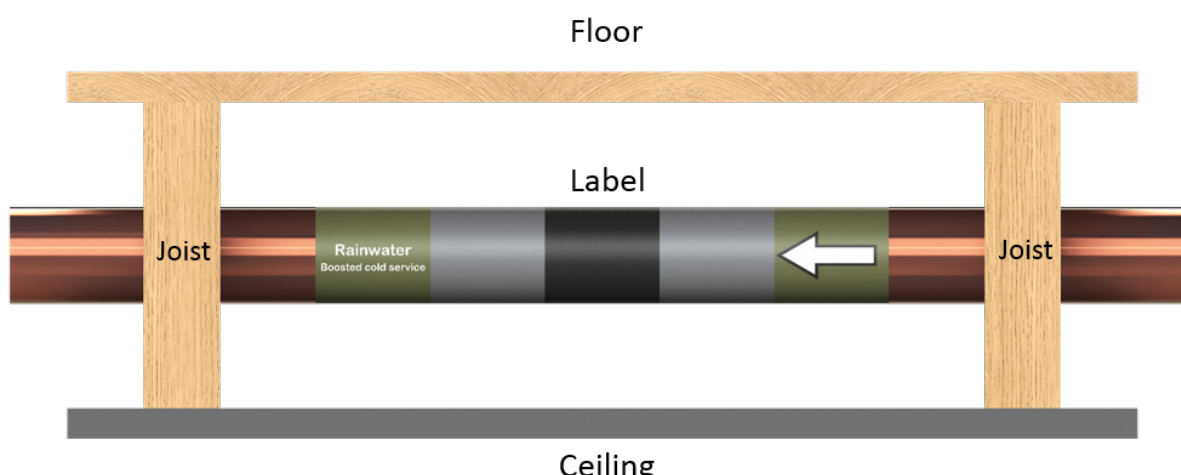

Marking of pipework in areas not easily exposed. When only small sections of pipework are visible for example

between floor joists, a label should be applied at least in every void as demonstrated.



Pipework & Labelling

All rainwater storage facilities and points of use, garden taps and washing machines for example, should be

clearly labelled using the above signage as shown. (Available to purchase from FloPlast)



Examples of the labels that should be used at stop valves and other key connection points.



Any pipework carrying rainwater, to other points of use, that is located outside the building should be black plastic pipe marked with green horizontal stripes at

the four quadrants as illustrated. Labels are available to purchase from FloPlast but are not supplied as part of the standard package.

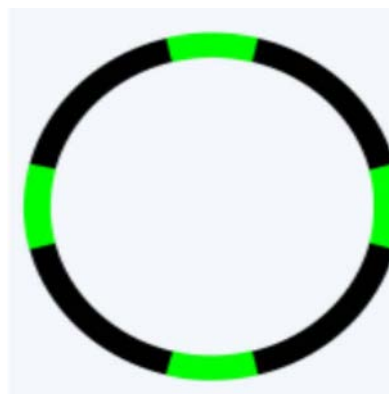
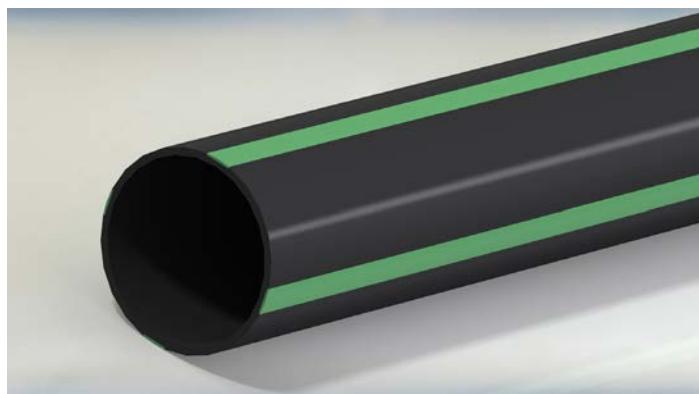



Optional Extras

The following items can be added to the Stormsaver system to increase its functionality. They will help the customer to keep track of how well the system is operating and also provide it with some extra features depending on what the customer specifies.

Level sensor kit:

This provides a tank contents reading on the control units display panel. It can be calibrated to show the tank contents between 0-100%. Instructions are supplied with the kit for self fitting.

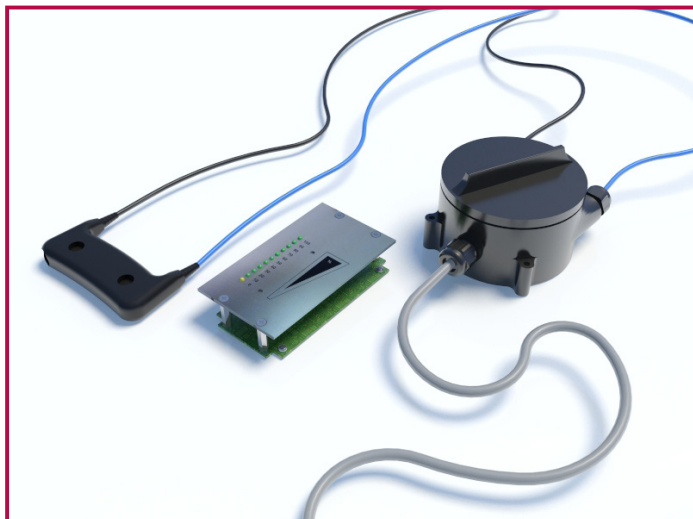

All optional extras can be discussed with a representative at FloPlast, however, they are not supplied as part of the standard package

Water Metering:

Water meters can be fitted within the system to monitor the amount of water passing through the system and therefore how much water the customer has saved thanks to rainwater harvesting.

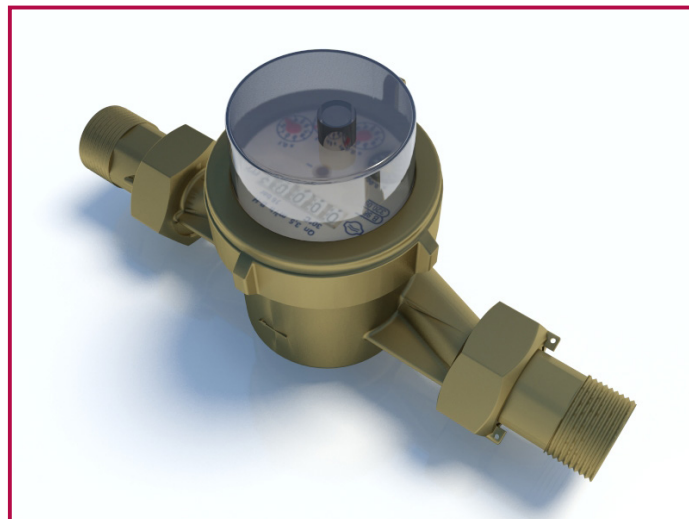

UV Sterilisation :

A ultraviolet disinfection unit can be fitted within the system. This sterilizes the water prior to use. The UV unit is available as an optional item from FloPlast Ltd.





Running the System and Troubleshooting

Stormsaver Storage Tank



1. Inlet Pipe
2. Rainwater tank
3. Rain Activ Filter
4. Inlet calmer
5. Overflow to drain
6. Boosted floating suction filter kit
7. Float switch
8. Service duct
9. 1/2" Suction hose

Stormsaver Control Panel System

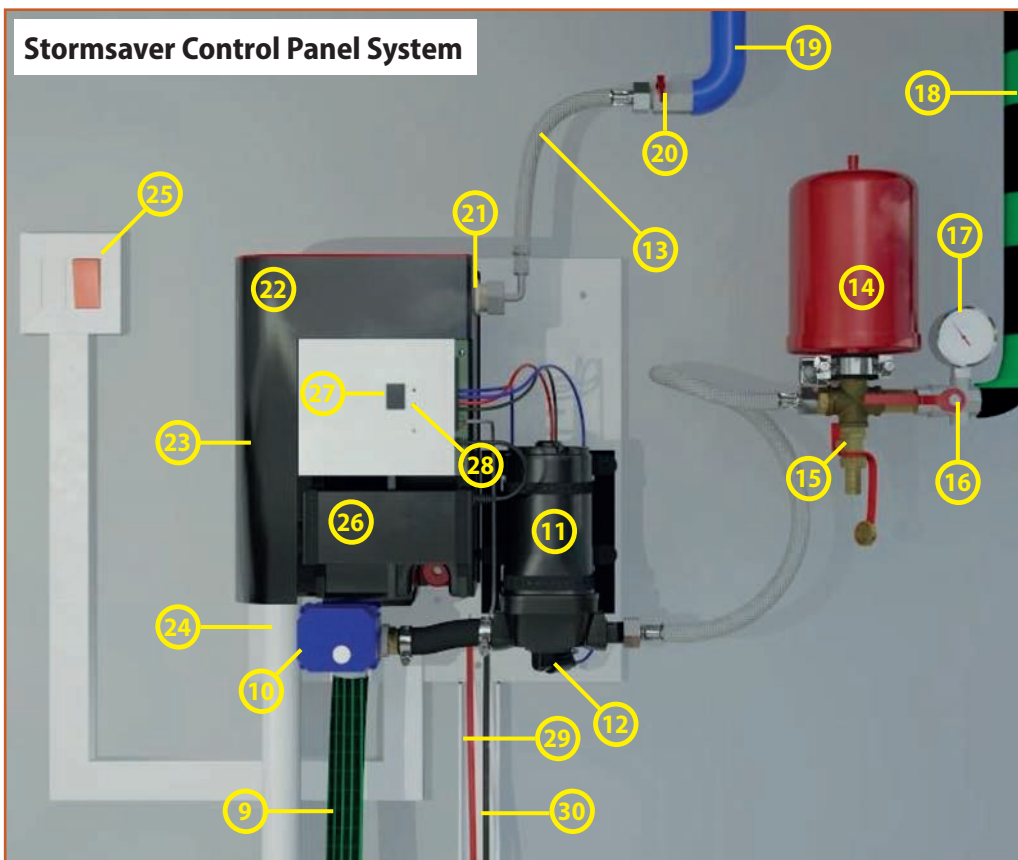

10. Motorised valve
11. Pump
12. Pressure switch
13. Stainless steel braided hose
14. Pressure vessel
15. Air bleed valve (closed during operation)
16. Isolation valve (shown open)
17. Pressure gauge
18. Pumped outlet usage line
19. Mainswater pipe
20. Mainswater shut-off valve (shown closed)
21. Mainswater supply valve
22. Mainswater supply tank
23. Type 'AA' airbrake
24. Waste pipe to drain
25. Fused spur Electrical supply
26. Power supply
27. Switch (auto/maintenance mode)
28. LED indication lights
29. Float switch cable
30. Boosted pump cable

When in operation both valve 16 and 20 must be in the open position.



Running the System and Troubleshooting

Preparing to turn the system on

The floating valve keeps the water level constant in the mainswater supply container. The maximum water level should be approx. 2 cm below the overflow rim when the floating valve is closed (backside of the container). The water level can be adjusted by twisting the black float. The floating valve incorporates a protective sieve to prevent particles entering the valve. If there is a problem with the mainswater supply it is important to check this sieve is not blocked.

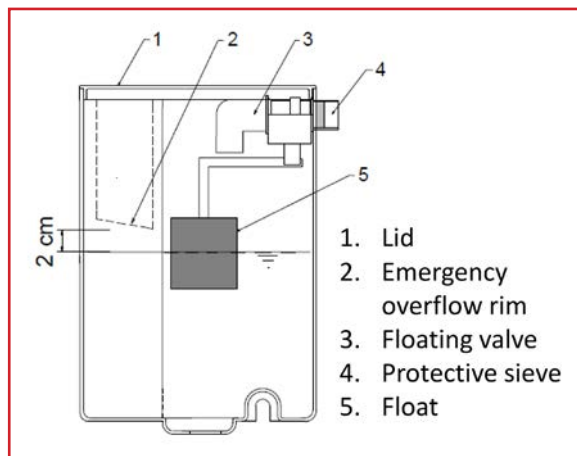

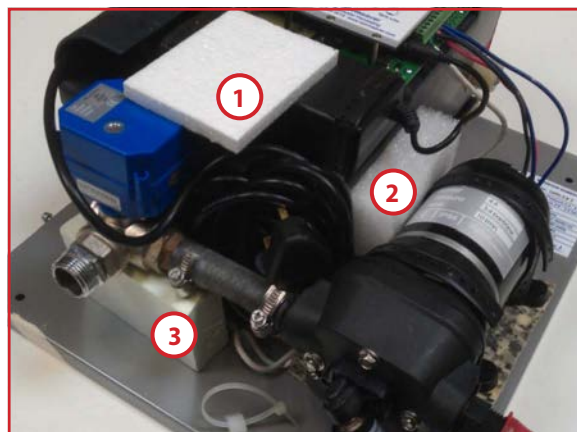

The foam and polystyrene parts 1-3 are packaging to protect the system during transport and must be removed before the system is turned on.



Mains water mode

The motorised valve selects between rainwater intake and mains water intake. The built-in display shows which mode is currently selected.

The motorised valve selects between rainwater intake and mains water intake. The built-in display shows which mode is currently selected.

-  **Mains water mode**
(Connection of mainswater supply container -> Pump)
-  **Rainwater mode**
(Connection of rainwater tank -> Pump)



Running the System and Troubleshooting

Starting mains water operation

The rainwater mode can only operate if there is sufficient water in the the rainwater tank. Check tank low level display light is not on.

1. Check that all lines are connected.
2. Select Maintenance mode = **switch position II**
Opens the mains water shut-off valve so that the mainswater supply tank is filled with water.



3. Close the isolation valve.



4. Open the air bleed valve (hold an empty bucket under the air bleed valve) and start the pump by switching on the mains power at the fused spur. It is helpful to use a short length of pipe from the air bleed valve to the bucket to stop splashing. Let the water run from the air bleed valve into the water bucket until there is no more sign of bubbles (a clear stream).



5. Close the air bleed valve.



6. Open the isolation valve and release the air from the (house) line (e.g. by pressing the toilet flush several times). Close the isolation valve. The pump will automatically switch off when the maximum system pressure is reached.





Running the System and Troubleshooting

Starting rainwater operation

The rainwater mode can only operate if there is sufficient water in the the rainwater tank. Check tank low level display light is not on.

1. Select automatic mode = **Switch position 1**
The motorised valve will move into the automatic mode position.



2. Close the isolation valve.



3. Open the air bleed valve (hold an empty bucket under the air bleed valve) and start the pump by switching on the power at the fused spur. Let the water run from the air vent into the water bucket until there is no more sign of bubbles (a clear stream), so that all the air is removed from the suction line.



4. Close the air bleed valve.



5. Open the isolation valve and release the air from the (house) line (e.g. by pressing the toilet flush several times). Close the isolation valve (house line). The pump will automatically switch off when the maximum system pressure is reached.





Running the System and Troubleshooting

Operation mode and display

Automatic rainwater operation with switch position 1

Automatic mode is the normal operating mode, and selected by Switch position 1. This is indicated by the upper LED. In this mode, the unit automatically switches from rain water to mains water, if the float switch detects the rainwater tank is empty. Two operating modes can be used according to the two positions of the float switch, both of which are indicated by the lower LED:

Rainwater mode, if this light is OFF it indicates that the Rainwater Tank is full.

Mains water mode, if this light is ON it indicates that the Rainwater Tank is empty.



Mainswater operation with switch position II

The maintenance mode is selected by Switch Position II. The mode is selected only when maintenance is to be performed in the tank. The control panel then operates in continuous mains water mode independent of the float switch.

Malfunction signal:

- All three LEDs blink together
- Cause: Dry running or unit has run continuously for no more than 2 hours
- Reset by disconnecting the plug from the electrical socket for a minimum of 5 sec. until all LEDs have gone off.

Starting operation again

Switch off and on again at fused spur isolator. If water is drawn and/or no pressure builds then there is air in the lines. Venting is done with the air bleed valve as described in the section "Starting operation". Check that there is water in the storage tank and check the condition of the float switch.



Maintenance mode
„Mains water mode“



Running the System and Troubleshooting

Troubleshooting

| Switch position I or II | Cause | Solution |
|------------------------------------------------------------------------------------------------------------------------------------------------------------------------------------------------------|--------------------------------------------------------------------------------------------------------------------------------------------------------------------------------------------------------------------------------------------------------------------------------------------------------------------------|----------------------------------------------------------------------------------------------------------------------------------------------------------------------------------------------------------------------------------------------------------------------------------------------------------------------------------------------------------|
| Pump does not switch on | <ul style="list-style-type: none"> a. Voltage supply not connected b. Pump pressure sensor defective c. Switch-on pressure is not low enough d. Temperature protection switch is activated, pump is overloaded because of insufficient flow volume e. Motor defective | <ul style="list-style-type: none"> a. Check the electrical plug. Check the pump cable b. Replace the pressure sensor. c. Max. Consumption 10m geodetic height d. Pump switches on again when motor is cooled down e. replace pump |
| Pump does not switch on + all LEDs blinking | <p>Pump protection is activated because permissible running time of 2 hours was exceeded:</p> <ul style="list-style-type: none"> a. Because of too little water b. Because of a leak c. Because of continuous operation | <p>Reset by switching fused spur off and back on (min 5 sec.)</p> <ul style="list-style-type: none"> a. Check system for low water level. b. Fix leak (put a hose underwater from air, bleed to see if it has air in the water.) c. Avoid continuous operation (by fixing A&B) |
| Pump does not switch off | <ul style="list-style-type: none"> a. Shut-off pressure cannot be reached because there is air in the system b. Pressure switch does not detect switch-off pressure (>2.5 bar) | <ul style="list-style-type: none"> a. Remove air from lines (see section on starting operation) b. Replace pressure switch |
| Pump cycling a. Shut-off ball valve open on pressure side (System pressure decreasing) b. Pressure shut-off ball valve closed on pressure side (System pressure excessive, over 5 bar) | <ul style="list-style-type: none"> a. - Leaky usage line - Drawing of water too low - Upstream pressure in pressure vessel diaphragm - pressure container too low b. Pressure switch defective | <ul style="list-style-type: none"> a. - Fix leak - Increase flow volume - Adjust upstream pressure if pressure vessel (1,6 bar) b. Replace pressure switch |
| Pump cannot reach max. pressure | <ul style="list-style-type: none"> a. Air in the system b. Pump diaphragm worn | <ul style="list-style-type: none"> a. Repeat start-up operation for potable water and rainwater b. Replace pump |
| Switch position I | Cause | Solution |
| Flow volume too low or pump not pumping enough water | <ul style="list-style-type: none"> a. Tank intake filter blocked b. Suction hose bent/ creased c. Leak in suction hose or connections | <ul style="list-style-type: none"> a. Clean the floating intake filter b. Check the suction hose c. Check the suction hose and connections d. Check the positioning of the suction hose in relation to the float switch position in the rainwater tank and correct it if necessary or replace floating switch. |
| The system does not switch automatically from rainwater to mains water operation and vice versa. | <ul style="list-style-type: none"> a. The float switch is not positioned correctly or is defective b. The motorized valve does not switch over despite the float switch signal. | <ul style="list-style-type: none"> a. Check the positioning of the intake filter in relation to the float switch position in the rainwater tank and correct it if necessary or replace the float switch. b. Replace motorized valve |
| Switch position II | Cause | Solution |
| Flow volume too low or pump not pumping enough water | <ul style="list-style-type: none"> a. Too little or no water in the mainswater tank b. The motorized valve does not switch over in maintenance mode. | <ul style="list-style-type: none"> a. Check upstream pressure on mainswater, if necessary clean the filter in the supplemental supply valve, or replace the supplemental supply valve if required b. Replace motorized valve. |



Running the System and Troubleshooting

Maintenance

To be checked a minimum of once per year:

- Leak-proof condition of all connections
- Leak-proof condition of the supplemental supply valve (check emergency overflow); the cover should be taken off if required
- Check the functionality of the floating switch; operate the floating switch manually for this
- Check that the intake filter can move freely and clean the sieve if necessary
- Check the upstream pressure of the diaphragm pressure container (upstream pressure=1,6)

Procedure: Switch off at isolator, close the pressure shut-off valve, release water by opening the air bleed valve, check the upstream air pressure up on the air valve using an air pump with manometer (e.g. bicycle or car tyre pump) If the upstream pressure is too low then the required pressure is to be attained again using the air pump.

Replacement Parts

Replacement parts can be ordered by giving the serial number.

Warranty

FloPlast undertakes a warranty of 12 months for this equipment, calculated from the date of purchase. Please retain the purchase receipt as proof of this date. During the warranty period FloPlast remedy all defects which are caused by manufacturing errors. FloPlast will fulfil the parts only guarantee by its own choice either through repair or by replacing of the defective equipment. Warranty does not cover damage caused by inappropriate use, wear and tear or tampering by third parties. The warranty does not cover shortcomings which have only a minor effect on the value or usability of the equipment. FloPlast is not an installer of equipment and does not carry out site installation work. Any defective parts should be returned to FloPlast upon which we will replace parts covered by warranty.

Contact address: FloPlast Ltd, Castle Road, Eurolink Business Park, Sittingbourne, Kent ME10 3FP

If you require maintenance, please contact FloPlast on 01795 431731.

| Article description | Order code |
|------------------------------------------------------|----------------|
| Diaphragm pump incl. pressure switch | 24/MSPA/01 |
| Pressure switch for diaphragm pump | 24/MSPA/02 |
| Motorized actuator valve | 24/MSPA/03 |
| Power supply 24 VDC, 4 A | 24/MSPA/04 |
| Printed control board | 24/MSPA/05 |
| Supplemental supply ball float valve for mains water | 24/MSPA/06 |
| Pressure vessel 2 l | 24/MSPA/07 |
| Equipment cover | 24/MSPA/08 |
| Low level float switch | 24/MSFS/01 |
| Boosted submersible pump | 24/MECO/FSF/BP |

FloPlast

building the future

Contact Details:

FloPlast Limited
 Castle Road
 Eurolink Business Park
 Sittingbourne
 Kent ME10 3FP
 UK

Tel
 01795 431731

Sales Office Direct Line
 01795 421422

Fax
 01795 431188

E-mail
 sales@floplast.co.uk

Website
 www.floplast.co.uk



April 2020

Brochures available:

